

C
10.5"
267



Hannay Reels®
The reel leader.

Ordering & Accessory Guide

Information on ordering reels and specifying accessories for reels:

- Hannay Reels Sales Policies
- Selecting the right reel
- Hose & Cable Reel components
- How to specify a Hannay Reel
- Common Parts & Accessories
- Hannay Accessory Order Form



- Rewind Assemblies
- Bearings
- Circuit Breakers
- Roller Assemblies
- Rewind Motor options
- Brakes & Locks
- Hose & Cable Stops
- Speed Controls and more



Family owned and operated since 1933

CONTENTS

Selecting the Reel

Part I: Reel Ordering Guide	Page
Selecting the Reel	3
Reel Components	4-5
The Anatomy of a Hannay Hose Reel	4
General Specifications of Hannay Hose Reels	4
The Anatomy of a Hannay Cable Reel	5
General Specifications of Hannay Cable Reels	5
Ordering Options	6
How to Specify Hannay Reels	7-9
General Ordering Information	7
Specifying Location of Components	8
Specifying Spring Rewind Reels	9
Hose and Cable Roller Positions	9
Part II: Accessory Ordering Guide	Page
Brakes and Locks	10
Clutch and Reduction Assemblies	11
Inline Gearbox	11
Electric Rewind Motors	12
Compressed Air Rewind Motors	13
Hydraulic Rewind Motors	13
Rewind Assemblies for Gear Driven Rewind Reels	13
Switches and Speed Controls	14
Circuit Breakers and Solenoids	15
Utility Hose Rollers and Parts	16
Spring Rewind Reel Roller Assemblies	17
FH-3 Roller and Spool Assemblies	17
Hose and Cable Stops	18
Hose Assemblies	18
Hannay Reels Accessory Order Form	19

Hannay Reels 3-Year Limited Warranty

Products manufactured by Hannay Reels, Inc. ("Hannay") are warranted for 3 years from date of shipment when properly installed, maintained, and operated in accordance with Hannay instructions. In no event will Hannay have a warranty obligation for normal wear and tear, or for products that have, at Hannay's determination, been subjected to accident, abuse, misapplication, improper installation or improper maintenance. Common examples of normal wear and tear would include paint finish, swivel joint seal wear, and switch or motor brush wear.

Hannay makes no warranties, express or implied, other than those included in this warranty statement, and we disclaim any implied warrant of merchantability or fitness for any particular purpose. Hannay will not be liable for any consequential, incidental, or indirect damages from any cause whatsoever.

Failure to use a flexible inlet connection on any live hose reel will void the swivel joint warranty. Failure to use a properly sized circuit breaker with any electric rewind motor will void the electric motor warranty. Failure to use a filter and lubricator on any air rewind motor will void the air motor warranty. Failure to follow all procedures outlined in the Safety Guidelines document will void the warranty. Components not manufactured by Hannay will be subject to the original manufacturers' warranties. Examples of such components include: hose and cable, motors, speed controls, and switches, swivel joints and seals, slip ring and brush assemblies.

Equipment which proves to be defective upon our inspection will be replaced free of charge, including freight to the customer. Our responsibility ceases upon delivery to any common carrier and we do not, unless previously instructed, insure shipments beyond point of delivery to such carrier. No material will be accepted for return without a return goods authorization (RGA). This warranty extends to the replacement or repair of the reel or part (no labor).

Hannay reserves the right to modify or alter materials, dimensions, design, and construction when necessary to improve the performance of the reel and/or accessories, or to meet delivery requirements.

Start with the Hose or Cable

Start with the hose/cable: the size, length, and type of hose/cable to be handled are primary factors in selecting the proper reel for your job. The following points should also be considered:

Hose: Be sure to use good quality hose rated for the service and operating pressures and temperatures to perform your application safely and efficiently. Poor quality hose tends to expand and contract under pressure surges, causing the reel to bind or even become distorted and inoperable. Check for proper temperature and pressure ratings and compatibility with the fluid you will be using whether it be fuel, corrosive chemicals and pesticides or water.

Cable: It is important to use good quality cable, properly sized, with the correct number and size of conductors to carry the required amperage and voltage. Compliance with local electrical codes should also be considered.

We have been manufacturing reels since 1933, and the reels listed in all of our catalogs are those found most in demand to handle hose/cable. Because our reels are assembled from a stock of standard components, we can produce many more sizes than are shown.

If the exact reel you need is not shown in any of the catalogs, please contact us with your specific requirements. In most cases, we can produce your reel from standard components, at no extra cost to you.

The drawing shows 2 reels with identical capacity although the **A** and **G** reel dimensions are quite different. In most cases, more than one reel model will handle a particular size and length of hose or cable. Once you determine the size and length of hose or cable you need, you can specify a reel with the dimensions best suited to the available space.

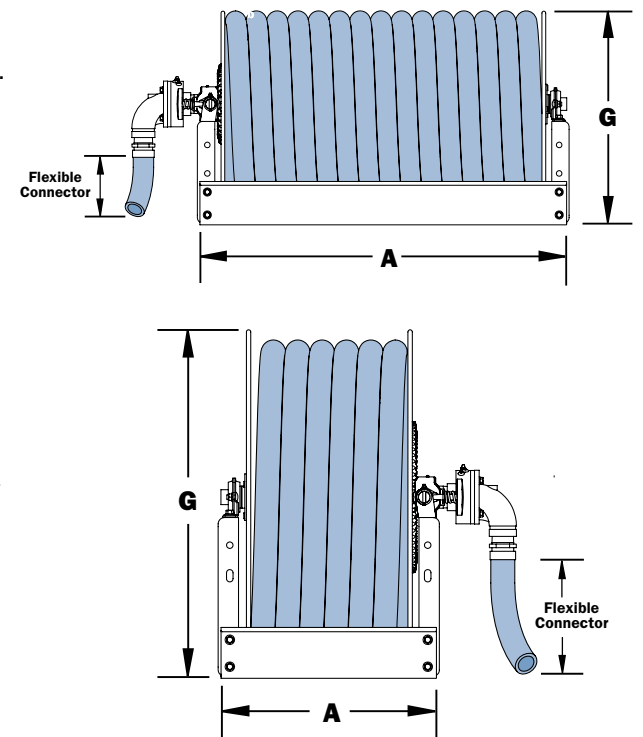

INSTALLATION NOTE: For the Hannay Warranty to be valid A FLEXIBLE CONNECTOR MUST BE USED BETWEEN THE SWIVEL AND THE INLET PIPING.

Return Goods Policy

All Hannay reels are built to order. These orders are typically placed into production within 1 business day of receipt. Once production begins, it may not be possible to cancel the order.

To prevent returns because the wrong reels or parts were ordered, please use the Hannay Reels Spec Worksheet (either online or from our Ordering & Accessory Guide) when specifying reels. Be sure to include any size, weight, pressure and/or material compatibility limitations for the application.

In the event that an item does need to be returned for credit, repair or replacement, prior approval must be obtained from Hannay Reels. Upon your request, we will send a Return Goods Authorization (RGA) form. A signed copy of this form must accompany the material when returned to us, with the RGA number clearly showing on the outside of the box—a label is provided to you that you can print and attach. No product will be accepted for return or credit without an authorized RGA number.

All material must be returned prepaid, unless otherwise noted on our RGA. No return will be accepted that has been damaged due to improper return packaging, tampered with or altered from its original condition. Our restocking and handling fee is a minimum of 25% for standard catalog reels and parts. Custom reels specially built to customer specifications cannot be returned for any reason.

Some Examples of Model Number Configurations

EF32-23-24 RT <i>(Electric rewind series "F" fire reel, standard pressure rating)</i>				1526-17-18 LT <i>(Manual rewind series "1500" reel, standard pressure rating)</i>			
EF	32-23-24	RT	--	--	1526-17-18	LT	--
Prefix	Model Number	Suffix	Pressure Rating	Prefix	Model Number	Suffix	Pressure Rating
Rewind/Type of Reel	Reel Size	Component Orientation <i>(see page 8 for options)</i>	(Standard psi)	Rewind	Reel Series & Size	Component Orientation <i>(see page 8 for options)</i>	(Standard psi)
HD6024-23-24 RT H5M <i>(Hydraulic rewind series "6000" reel, 5,000 psi)</i>				N716-23-24-15.5J SR H10M <i>(Spring rewind series "N700" reel, 10,000 psi)</i>			
HD	6024-23-24	RT	H5M	N	716-23-24-15.5J	SR	H10M
Prefix	Model Number	Suffix	Pressure Rating	Prefix	Model Number	Suffix	Pressure Rating
Rewind	Reel Series & Size	Component Orientation <i>(see page 8 for options)</i>	(5000 psi)	N Series Frame	Reel Series, Size & Type of Spring	Roller Orientation <i>(see page 9 for options)</i>	(10,000 psi)

Common Prefix Options

E = Non-Explosion Proof Motor	A = Air	C = Cable Storage
EF = Non-Explosion Proof Motor (Fire)	AG = Air Governor	MX = Gear & Sprocket Crank Rewind
EP = Explosion Proof Motor	HD = Hydraulic	T = Twin Spool
EPJ = Explosion Proof Motor with Explosion Proof Switch & Junction Box	HDD = Direct Drive Hydraulic	V = Aviation

Hose Reel Components

The Anatomy of a Hannay Hose Reel

1 Bearings

Weight of spool and hose is supported by two bearings - one on each side of the reel.

2 Disc

Rolled edges prevent hose damage and add rigidity to disc. Additional strength is provided by a concentric rib.

3 Drum

Roll formed steel with full-length weld.

4 Tie rods

Join discs and drum to form spool. Reinforced with pipe spacers for rigidity and strength.

5 Chain and sprocket drive

Provides smooth positive rewinding on powered reels.

6 Rewind motor

Electric rewind motor is shown. Compressed air, hydraulic or spring motors can be used.

6a Electric junction box

7 Hub assembly

Includes the fluid hub, the outlet riser, and the reel axle. Fluid passes from the swivel joint inlet through the hub assembly, to the hose.

7a Outlet riser

Contoured to match the curve of the reel drum so hose will wrap smoothly.

7b Fluid hub

8 Swivel joint inlet

Permits reel to rotate freely while connected to the fluid source. Straight or 90° swivel joints are available for most models. (Flexible connector must be used between swivel joint and inlet piping or warranty will be void.)

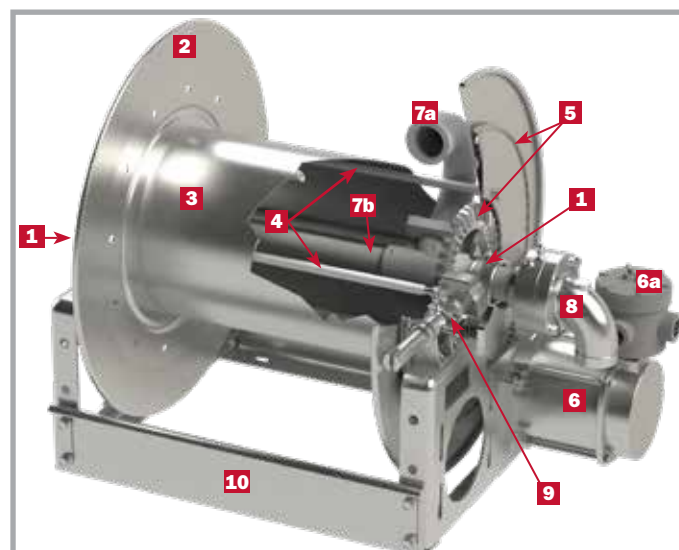

This cutaway illustration shows a typical power rewind reel with an optional auxiliary crank rewind mechanism. All Hannay reels are assembled from combinations of the basic components shown here. Since components are taken from a large inventory, each reel is assembled to the buyer's particular requirements.

9 Brake/rewind assembly

Bevel gear rewind has an adjustable tension brake. Rewind and braking devices vary with different models.

10 Frame

Durable, heavy-duty frame for maximum reel support.

General Specifications of Hannay Hose Reels

Construction:

Frames, discs, and drum are fabricated of heavy-gauge steel. Bearings are self-aligning. Malleable iron and steel are used for hose reel hub assembly, outlet riser, and swivel joints. Stainless steel, aluminum, and special swivel joint packing can be supplied to meet special requirements.

Finish:

Standard finish is oven-cured enamel. Finishes other than standard, such as special primers, may be specified at extra cost.

Temperatures and Pressures:

Standard reel construction will handle most liquids or gases at temperatures ranging from -20° to +400° F (-29° to +204° C). Operating pressures available up to 10,000 psi (690 bar) or more, depending on the specific reel series. These operating pressures and temperatures are shown on descriptive pages in each product catalog.

Reels to operate at pressures and temperatures other than standard are available at extra cost.

Shipping:

Reels are shipped completely assembled, ready to install. Installation instructions are supplied with each reel.

Cable Reel Components

The Anatomy of a Hannay Cable Reel

1 Bearings

Weight of spool and hose is supported by two bearings - one on each side of the reel.

2 Disc

Rolled edges prevent cable damage and add rigidity to disc. Additional strength is provided by a concentric rib.

3 Drum

Roll formed steel with full-length weld.

4 Tie rods

Join discs and drum to form spool, reinforced with pipe spacers for rigidity and strength.

5 Chain and sprocket drive

Provides smooth positive rewinding on powered reels.

6 Hub assembly

Provides wiring access to the slip ring assembly and serves as the reel axle. Cable is connected to the slip ring assembly, passes through hub and exits drum through a grommated hole.

7 Collector ring

Provides electrical continuity through reel as cable is payed out or retrieved.

8 Collector ring cover

Provides protection from current carried through collector ring assembly as well as keeping out contamination.

9 Wiring junction box

Provides connection of reel to incoming power source.

10 Brake/rewind assembly

Bevel gear rewind has an adjustable tension brake. Rewind and brake devices vary with different models.

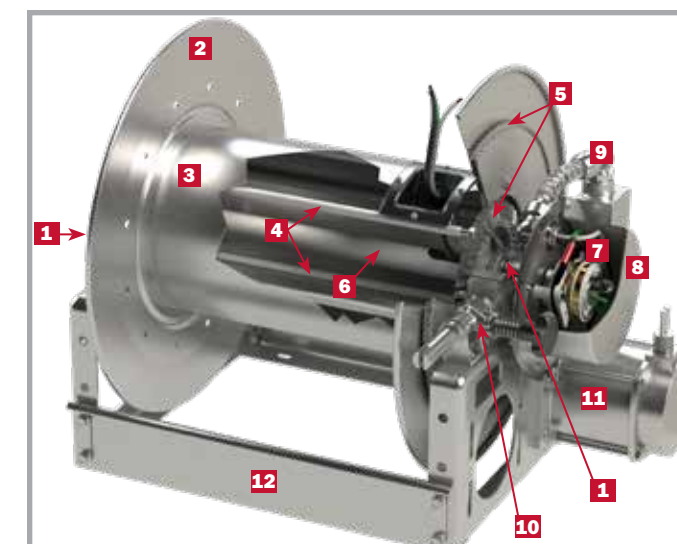

This cutaway illustration shows a typical power rewind reel with an optional auxiliary crank rewind mechanism. All Hannay reels are assembled from combinations of the basic components shown here. Since components are taken from a large inventory, each reel is assembled to the buyer's particular requirements.

11 Rewind motor

Electric rewind motor is shown. Compressed air, hydraulic or spring motors can be used.

12 Frame

Durable, heavy-duty frame for maximum reel support.

General Specifications of Hannay Cable Reels

Construction:

Frames, discs, and drum are fabricated of heavy-gauge steel. Bearings are self-aligning.

Electrical Connections:

A pull wire is provided for installing cable through drum and hub. Connection from the electrical source to the reel is through a junction box or a pre-connected wire lead, depending on the reel model.

Collector Ring Assembly:

Reels to handle live electric cable are normally equipped with a 3-conductor collector ring assembly. Assemblies with additional conductors and for higher amperage are available at extra cost on most models. Be sure to specify your application.

Standard:

45A 600V standard. Up to 300A available at additional cost.

Finish:

Standard finish is oven-cured enamel. Finishes other than our standard, such as special primers, may be specified at extra cost.

Shipping:

Reels are shipped completely assembled, ready to install. Installation instructions are supplied with each reel.

Ordering Options

Hub Assembly Options

The hub assembly is the heart of the hose reel. It includes the outlet riser, the reel axle, and the threaded inlet to which the swivel joint is attached. The swivel joint permits the reel to rotate freely while connected to the fluid source.

The outlet riser is engineered to conform to the contour of the drum so the hose lies smoothly against the drum without kinking. Smooth interior surfaces are flow-contoured for unrestricted flow and minimal pressure loss through the reel.

A 2-way flow hub assembly is available on certain models as an option. On this assembly, the reel axle is threaded on both ends so the swivel joint can be attached at either end to match piping. A pipe cap is supplied to seal the opposite end.

Standard Hub Assembly

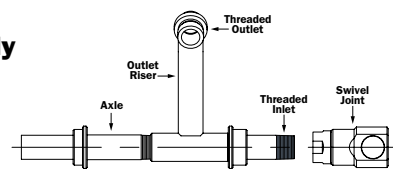

Standard Hub Assembly with Optional Flanged Riser

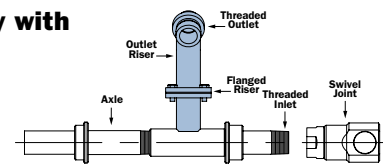

Optional 2-Way Hub Assembly Shown with Optional Flanged Riser

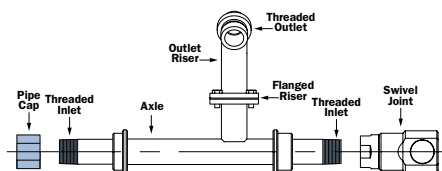

Rewind Options

Manual Rewind Reels

1. Gear-driven manual rewind reels are equipped with a crank operated ring gear mechanism. This mechanism can be used to provide an auxiliary rewind capability on certain power rewind reels.
2. Disc rewind reels are rewound by manually turning the reel discs (not shown).
3. Direct manual rewind reels are equipped with either a permanently attached or removable crank (depending on model) which attaches to the reel axle to rewind the reel.
4. Chain-driven manual rewind reels are equipped with a crank operated chain and sprocket mechanism parallel to the reel axle (not shown).

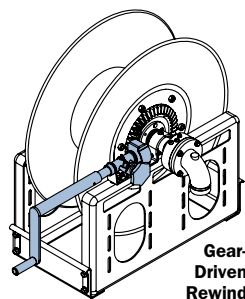

Gear-Driven Rewind

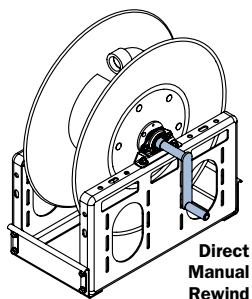

Direct Manual Rewind

Spring Rewind Reels

1. Spring motor module – Tamper-proof spring housing protects the spring and eliminates risk of injury to the operator. Powerful spring delivers positive rewind power through thousands of cycles without power loss.
2. Ratchet assembly – Locks the reel at any point when hose/cable payout stops. A pull on the hose/cable disengages the lock for instant rewinding. This assembly is deleted for automatic payout and rewind for constant tension applications.
3. Declutching arbor – Disengages the spring to prevent damage from reverse winding.

Because they utilize self-contained rewind power, spring rewind reels are extremely versatile. No power connections are required and the reels can be installed in virtually any position and on all types of equipment.

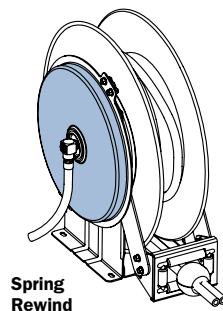

Spring Rewind

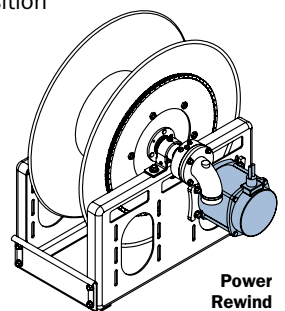

Power Rewind

Power Rewind Reels

A chain and sprocket mechanism is used on reels with power rewind; the chain drive assures smooth, positive power transmission and minimum maintenance.

A choice of electric, compressed air or hydraulic motors is offered for power rewind reels. Specific information on motors and operating controls is listed on pages 12, 13, and 14.

General Ordering Information

A precise and complete purchase order is your best assurance of prompt delivery of the exact reel you need. Your order should include all information listed. It is better to over specify than to omit important information.

When space permits, select a reel with greater capacity than you actually need. This allows you to rewind the hose/cable with less care and keeps the hose/cable well protected within the disc dimension even if it is not wound in uniform coils. In most cases, the larger reel, in the same series, costs no more.

Continuous-Flow Hose Reels

Orders for all continuous-flow hose reels should specify:

- Complete model number
- Type of rewind
- Length, ID and OD of hose(s)
- Maximum working pressures
- Size and thread of outlets
- Minimum bend radius
- 90-degree (standard) or straight swivel joint
- Liquid, gas or other product to be handled
- Oxygen/acetylene use
- Product temperature range
- Finish, if other than standard
- How reel will be installed and used
- Accessory items required

Live Electric Cable Reels

Orders for live electric cable reels should specify:

- Complete model number
- Type of rewind
- Gauge, length, OD and weight of cable
- Cable voltage and amperage
- Minimum bend radius
- Number of conductors required
- Finish, if other than standard
- How reel will be installed and used
- Accessory items required

Dry Storage Reels

Orders for dry storage reels should specify:

- Complete model number
- Length, OD, and weight of hose, cable, rope or other material to be handled
- Bending radius, if material is not easily coiled
- Type of rewind
- Divider disc spacing, if required
- Finish, if other than standard
- How reel will be installed and used
- Accessory items required

Power Rewind Reels

Orders for power rewind reels must also specify:

- Voltage and phase for electric motor
- Air or hydraulic rewind
- With or without auxiliary crank rewind

Spring Rewind Reels

Orders for spring rewind reels must also specify:

- Roller position SR (standard), VR or TR (see page 9)
- Hose stop, if required [specify OD of hose(s) or cable(s)]
- Ratchet locking (standard) or without ratchet for automatic operation
- Height of lift, if reel is to lift hose/cable and weight of hose/cable with or without load
- Describe installation in terms of lift, stretch, drag or recovery (see page 9)

INSTALLATION NOTE: For the Hannay Warranty to be valid:

1. A FLEXIBLE CONNECTOR MUST BE USED BETWEEN THE SWIVEL AND THE INLET PIPING, (see illustration on page 3 of this catalog).
2. On DC electric rewind reels, a circuit breaker must be installed between the battery and the rewind motor.

How to Specify Hannay Reels

How to Specify Hannay Reels

Specifying Location of Components

Optional Location of Components

Location of the inlet, outlet riser, and rewind mechanism can be varied to meet your requirements and **must be specified on your order**. The drawings below show the component locations. Unless otherwise specified, most reels will be shipped as **Right Top Rewind** with the inlet, outlet riser, and rewind mechanism on the operator's right.

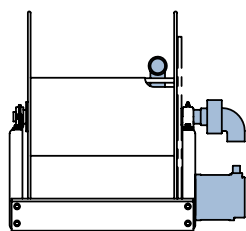

RT – Right Top Rewind

Reels have the inlet, outlet riser, and rewind mechanism on the operator's right. Hose unwinds from the top of the reel.

Standard – Always look at your reel from this position to determine right hand or left hand.

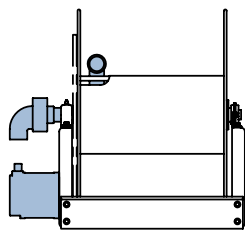

LT – Left Top Rewind

Reels have the inlet, outlet riser, and rewind mechanism on the operator's left. Hose unwinds from the top of the reel.

Standard for 1500, 1800 and 4000 Series reels.

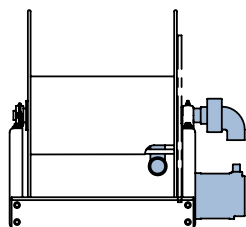

RB – Right Bottom Rewind

Reels have the inlet, outlet riser, and rewind mechanism on the operator's right. Hose unwinds from the bottom of the reel.

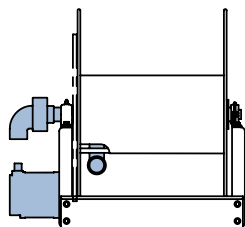

LB – Left Bottom Rewind

Reels have the inlet, outlet riser, and rewind mechanism on the operator's left. Hose unwinds from the bottom of the reel.

Note: Use component location initials as suffix **after** model number (ie: EF32-23-24 RT)

Optional Motor Locations

Electric rewind motors can be installed in any of the positions shown in these drawings. The Bottom Rear position is standard. The motor is installed inside the frame on Model ESF reels (see Firefighting catalog), which are designed for installation in restricted space.

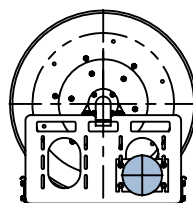

Bottom rear (Standard)

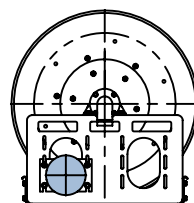

Bottom front

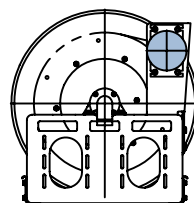

Elevated 2 o'clock

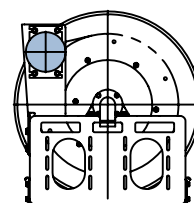

Elevated 10 o'clock

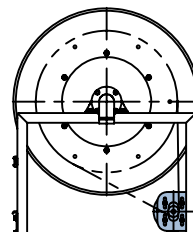

Inboard (ESF Reels)

Optional Auxiliary Rewind Positions

Horizontal ring and pinion gear crank rewind mechanism is the standard configuration.

Optional positions include vertical and 30° above centerline, as shown in these drawings. Both are available at extra cost and **must be specified**.

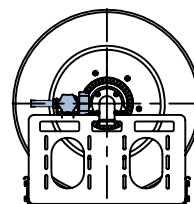

Horizontal (Standard)

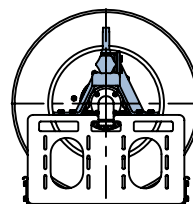

Vertical

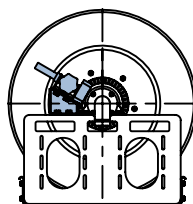

30° Angle

How to Specify Hannay Reels

Specifying Spring Rewind Reels

Important Installation Guide

For proper reel operation, rewind springs must be precisely matched to the job. Your order should include a detailed description of how the reel will be installed and used. This will also help to determine the best roller position.

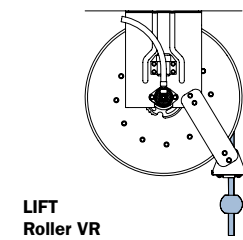

LIFT Roller VR

Vertical Lift

Reel is installed overhead, on wall or ceiling, to lift hose/cable and product being handled. Spring must have power to lift total weight of hose/cable **plus any weight which will be attached to the hose/cable** such as a power tool. Reel can be manually operated or pay out and rewind **automatically**. Specify height of lift and weight of hose/cable and attachments when you order.

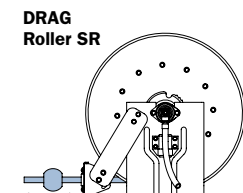

DRAG Roller SR

Drag

Reel is stationary and retracts hose/cable across floor or other surface. Spring must have power to compensate for friction. Reel can be manually operated or pay out and rewind **automatically**.

Note: A rough drawing of your specific installation plans will be extremely helpful.

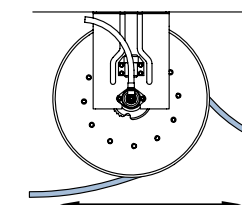

STRETCH 2-way payout No roller

Stretch

Reel is stationary and retracts suspended hose/cable attached to moving equipment. Reel pays out and rewinds **automatically**. Spring must have power to compensate for weight of unsupported hose/cable. Specify maximum hose sag allowable.

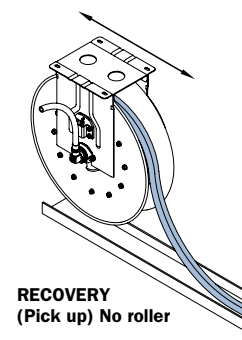

RECOVERY (Pick up) No roller

Recovery

Reel is installed on moving equipment or at a fixed center point to retract and pay out hose/cable in 2 directions. Reel pays out and rewinds **automatically**. If reel travels, specify speed of travel, acceleration rate, and height of reel above recovery surface.

REVERSE SPRING LOCATION

A reverse spring location option is available if your installation requires the spring to be mounted opposite side of the standard location.

For SR and VR roller reverse positions: swivel joint will be standard on the left, with spring on the right.

For TR roller reverse position: swivel joint will be standard on the right, with spring on the left.

Must specify REV in model number when ordering: ie: N716-19-20-10.5REV J

Hose and Cable Roller Positions

On standard spring rewind reels, the hose/cable pays out from the bottom of the reel and to the left when reel is viewed from the swivel joint or collector ring side. **Hose/cable rollers are supplied with all spring rewind models and you must specify the roller position when you order.** (If roller position is not specified, reels will be shipped with rollers in POSITION SR.)

Pricing Note: When reels are ordered for constant tension applications, the ratchet assembly and, in some cases, hose rollers are not required. See Price List for deductions.

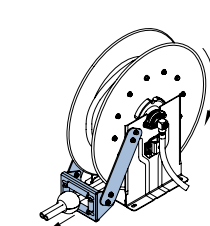

POSITION SR (Is standard) Swivel joint right

Specify roller position SR when:

- Reel will be installed in the upright position at any point from floor to eye level.
- Reel will be installed on a wall with hose/cable to be retracted close to the wall.
- Reel will be installed on ceiling and hose/cable will pay out parallel to and close to the ceiling.
- Inlet supply line will come in from the right.

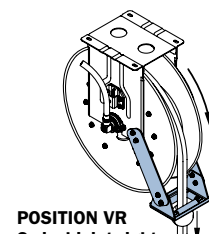

POSITION VR Swivel joint right

Specify roller position VR when:

- Reel will be installed in the upright position and hose/cable will be pulled upright from the reel.
- Reel will be installed on ceiling to lift hose/cable.
- Reel will be installed on a wall with hose/cable to be pulled straight out.

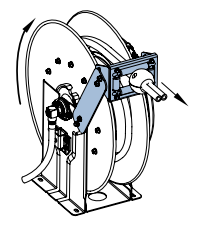

POSITION TR Swivel joint left

Specify roller position TR when:

- Reel will be installed on floor.
- Reel will be installed on ceiling with hose/cable to pay out parallel to the ceiling.
- Inlet supply line will come in from the left.

BE SURE TO SPECIFY ROLLER POSITION WHEN ORDERING.

Arrows show direction of reel rotation and direction in which hose/cable unwinds.

SAFETY NOTE: Never let hose or cable go and snap back, reel can be damaged and/or injury can result.

Accessories

• Brakes and Locks

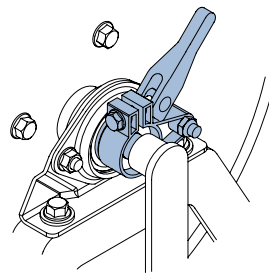

Cam-Lock Drag Brake

Molded plastic drag brake with cam-lock lever designed for 1/2" and 1" manual reels. Corrosion proof and does not harm the hub. There are 3 adjustable positions for the desired drag tension to prevent cable or hose overrun. Instantly releases with the flip of a lever for drag-free rewind.

To order specify part number:

- Cam-Lock Drag Brake Kit (1/2" reels) (P/N 9947.0130)

For factory installation: Specify Cam-Lock Drag Brake with reel order.

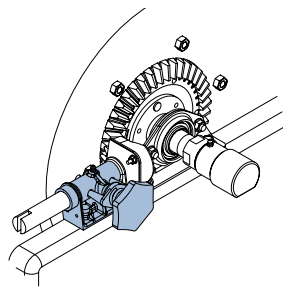

Pinion Brake

Adjustable spring tension applies braking pressure to pinion shaft on reels equipped with ring gear rewind mechanism.

To order specify part number:

- Pinion Brake Assembly (reels thru 25-26 series) (P/N 9914.0200)
- Pinion Brake Assembly (reels over 25-26 series) (P/N 9914.0210)

For factory installation: Specify Pinion Brake with reel order.

See additional options for space restrictions on Page 13.

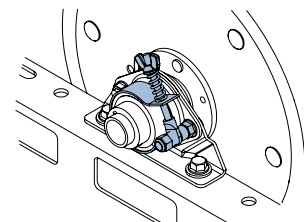

Strap (Comet) Brake

Adjustable steel strap lined with brake pad material applies drag pressure to reel axle to control payout speed of the reel.

To order specify part number:

- Strap Brake Assembly (Bearing Mounted Style) (P/N 9947.0090)

For factory installation: Specify Strap (Comet) Brake with reel order.

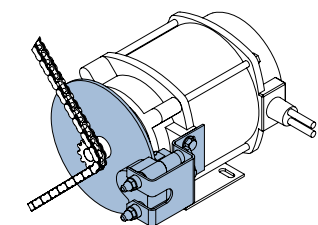

Caliper Brake

Pneumatically clamps a disc on the motor shaft for positive locking of reels with power rewind.

To order specify part number:

Air Caliper Brake, Standard (P-38) (P/N 9947.0020)

For factory installation: Specify Caliper Brake with reel order.

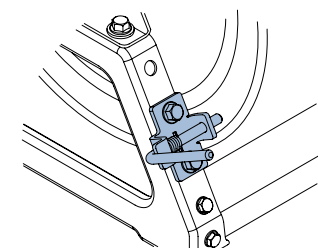

Pin Lock

A positive, spring-actuated pin lock to prevent free-wheeling or recoil from pressure surges. May be factory installed when specified with your reel order.

To order specify part number:

PL-1 Pinlock (P/N 9965.0030)

PL-4 Pinlock (P/N 9965.0036)

For factory installation: Specify Pin Lock with reel order.

Accessories

• Clutch and Reduction Assemblies • Inline Gearbox

Clutch and Reduction Assemblies

Hannay reduction units are used to increase the torque (by 50 to 400%, depending on the ratio chosen) and decrease the rewind speed on power-driven reels. The clutch allows the motor and reduction unit to be disengaged from the reel, eliminating drag in the unwinding mode. The manual clutch is disengaged by means of a user-operated pull rod. The electric clutch requires no user intervention. It automatically engages when the motor is running, and disengages when the motor stops.

Hannay reduction units and clutches are available as a kit for field installations, or can be factory installed when specified with the reel order.

Reduction unit kits include reduction unit, length of chain, connector links, and fasteners. Clutch/reduction kits include the clutch and reduction unit, length of chain, connector links, and fasteners.

Note: You must specify the reel model on which the assembly is to be installed.

Available Ratios	
Reduction Unit Only	Clutch and Reduction Unit
12/18	12/40
12/25	12/48
12/36	12/60



Electric Clutch and Reduction Unit

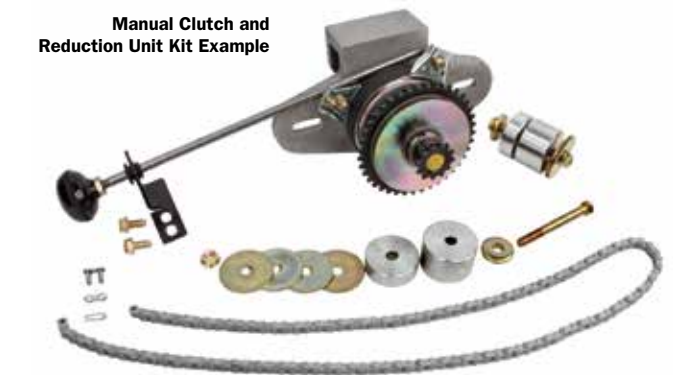

Manual Clutch and Reduction Unit Kit Example

Inline Gearbox

- Available in 3 reduction ratios—2:1, 3:1 and 4:1, so that almost any desired motor speed reduction and pull force requirement can be met.
- Bolts directly on the face of existing Hannay motors, making installation very easy
- Field retrofittable on existing reels
- Eliminates the complexity and extra maintenance associated with a traditional Hannay clutch/reduction unit—including two fewer sprockets and one less piece of chain.
- Better operator ergonomics – simple, low-force quarter turn of a knob to engage or disengage the clutch from the motor, compared to legacy clutch, which required 35 lbs of pull force to activate.



Inline Gearbox can be configured for the left or right side of a reel.



Accessories

- Electric Rewind Motor

Electric Rewind Motors

Circuit breakers must be used with all DC electric motors. Failure to use properly sized circuit breaker will void motor warranty. **Note:** Standard motor voltages available. 12V and 24V DC, 115V AC, 230V AC single-phase and three-phase motors available on special order.

12-Volt DC Motors

12V DC 1/5 HP Face Mount - AN-239

(P/N 9915.0040) Optional mounting plate available (P/N 9923.0008).

12V DC 1/3 HP Face Mount - AN-227

(P/N 9915.0042) Optional mounting plate available (P/N 9923.0008).



Face-Mount, Non-EP DC Motor
(Shown with optional mounting plate,
Part No. 9923.0008)

12V DC 1/2 HP Flange Mount - SX-001

Explosion Proof (P/N 9915.0003).

12V DC 2/3 HP Flange Mount - SX-743

Explosion Proof (P/N 9915.0010).



12V DC 2/3 HP w/Mounting Plate - SX-800

Explosion proof, three different mounting configurations (P/N 9915.0361)



24-Volt DC Motors

24V DC 1/3 HP Face Mount - AN-248

(P/N 9915.0173). Optional mounting plate available (P/N 9923.0008).



24V DC 1/2 HP Flange/Base - SX-123

Explosion Proof (P/N 9915.0113)



115-Volt AC Motors

115V AC 1/3 HP Face Mount - AN-351

(P/N 9915.0273)



115V AC 1/2 HP Flange/Base - SX-163

Explosion Proof (P/N 9915.0236)



For Motor Installation Instructions visit the [Maintenance & Installation Guides](#) section on our website.
(Refer to TSB 2013.08.006 Installation Instructions for DC and AC Electric Rewind Reels)

Accessories

- Air Rewind Motors • Hydraulic Rewind Motors
- Rewind Assemblies for Gear-Driven Crank Rewind Reels

Compressed Air Rewind Motors

NOTE: A fingertip control valve with integral back pressure relief and flexible air line from control valve to rewind motor are available and **must be ordered separately**. We recommend using a lubricator and filter with air rewind motors, which are **not supplied**.

#4 Gast Air Motor (Flange Mount) (P/N 9918.1122)

Schrader Valve (#3420) for #4 Motor (P/N 9919.0004)
1/4" Air Hose (18" length) for #4 Motor (P/N 9919.0007)

#6 Gast Air Motor (Flange Mount) (P/N 9918.1123)

Schrader Valve (#1415) for #6 Motor (P/N 9919.0005)
3/8" Air Hose (25" length) for #6 Motor (P/N 9919.0008)



For Motor Installation Instructions visit the [Maintenance & Installation Guides](#) section on our website.
(Refer to TSB 2013.08.003 Installation Instructions for Compressed Air Motors)

Hydraulic Rewind Motors

No other hydraulic components are furnished with the reel. A 4-way, 3-position control valve with motor spool is recommended but is **not supplied**.

Parker Hydraulic Motor (2/3 in³) (P/N 9918.2600)



For Motor Installation Instructions visit the [Maintenance & Installation Guides](#) section on our website.
(Refer to TSB 2013.07.002 Installation Instructions for Hydraulic Rewind Motors)

Rewind Assemblies for Gear-Driven Crank Rewind Reels

These assemblies are used to change the pinion shaft position on gear-driven crank rewind reels to meet space restrictions or for greater operator convenience. **NOTE:** Units can be factory installed, when specified with reel order, or supplied in kit form for field installation. Assemblies are complete with drag-brake assembly, pinion, gear guard, brake handle, and fasteners. Fits standard mounting holes on reel frame.

VR-2 Vertical Rewind Assembly (thru 25-26) (P/N 9914.0223)

Vertical Rewind Bracket Only (P/N 9914.0233)

30° Rewind Assembly (thru 25-26) (P/N 9914.0551)

30° Bracket Only (P/N 9914.0541)



Vertical Rewind Unit

30° Rewind Unit

Accessories

• Switches and Speed Controls for Electric Rewind Reels

Switches, Speed Controls and Combination Switches

12-Volt or 24-Volt DC Switches

90030 Series Switch

(P/N 9917.0004)

Sealed push-button switch with rubber cap.

Good for 12 or 24V DC service.



EXPB-2A-120 Switch

(P/N 9917.0001)

Explosion-proof, push-button switch.

Good for 12 or 24V DC service.



115-Volt or 230-Volt AC Switches

EXPBC-2B-120 Switch

(P/N 9917.0002)

Explosion-proof, push-button switch.

Good for 115 or 230V AC service.

(Hannay motors only)



PB-1 Switch

(P/N 9917.0045)

Weather-resistant (non-explosion proof), push-button switch.

Good for 115 or 230V AC service.

(Hannay motors only)



115-Volt or 230-Volt AC Reversing Switches

SB-115SR Reversing Switch

(P/N 9917.0087)

Reversing switch with rocker button and fuse.

Good for 115 or 230V AC service.

(Hannay motors only)



12-Volt or 24-Volt DC Speed Controls and Combination Switches

MD-70 Speed Control (P/N 9917.0080)

Variable speed control.

Good for 12 or 24V DC service; limited to 1/2 HP or smaller motors.



MD-1240S Switch and Speed Control

(P/N 9917.0071)

Push-button rewind switch, variable speed control, and 40 amp manual reset breaker.

Good for 12V DC service; limited to 1/3 HP.



MD-2425S Switch and Speed Control

(P/N 9917.0073)

Push-button rewind switch, variable speed control, and 25 amp manual reset breaker.

Good for 24V DC service; limited to 1/3 HP.



MD-12HDSR Heavy-Duty Reversing Switch and Speed Control (P/N 9917.0075)

Reversing rewind switch with rocker button, variable speed control, and internal circuit protection.

Good for use on all Hannay 12V DC motors.



MD-24HDSR Heavy-Duty Reversing Switch and Speed Control (P/N 9917.0076)

Reversing rewind switch with rocker button, variable speed control, and internal circuit protection.

Good for use on all Hannay 24V DC motors.



115-Volt or 230-Volt AC Speed Controls and Combination Switches

MD-115 Speed Control (P/N 9917.0041)

Variable speed control. Good for 115 or 230V AC service. (Hannay motors only)



MD-115HDSR Heavy-Duty Reversing Switch and Speed Control (P/N 9917.0092)

Reversing rewind switch with rocker button, variable speed control, and internal circuit protection.

Good for 115 or 230V AC service. (Hannay motors only)



Accessories

• Circuit Breakers • Solenoids

Circuit Breakers

Circuit breakers must be used with electric rewind motors. Failure to use properly sized circuit breaker will void motor warranty.

Compact Series Circuit Breaker (Economy)

Manual, push-button reset. Built-in mounting bracket. Other amperage ratings available, consult Factory.

25A Circuit Breaker

(P/N 9917.0171)



40A Circuit Breaker

(P/N 9917.0172)



SLDM Series Circuit Breaker (Heavy Duty)

Manual, push-button reset. **To Order:** Specify amperage and give model number of reel motor. Specify CB-2 bracket, if required.

40-AMP (P/N 9917.0020)

50-AMP (P/N 9917.0021)

70-AMP (P/N 9917.0022)



CB-2 Mounting Bracket for SDLM Breaker

To Order: Specify amperage and give model number of reel motor. Specify CB-2 bracket, if required. (P/N 9917.0024)



Solenoids

12-Volt Solenoids

12-Volt Standard

(P/N 9917.0025)



12-Volt Continuous Duty

(P/N 9917.0029)



12-Volt Weather Proof

(P/N 9917.0027)



24-Volt Solenoids

24-Volt Standard

(P/N 9917.0028)



24-Volt Continuous Duty

(P/N 9917.0026)



Accessories

- Utility Hose Rollers & Parts

Utility Hose Rollers

Stainless steel rollers and cast alloy brackets are available for use on reels, on cabinet door openings, truck platforms, and similar locations where sharp edges may cut or damage hose/cable.

Specifications: 1-1/2" diameter stainless steel roller, stainless steel rod, Delrin bearings, alloy brackets, and required fasteners. Also available factory installed on the reel, must specify when ordering.

To Order:

1. **Specify Assembly Required:** A A2 B B2 C C2

A2, B2, and C2 roller assemblies provide 1" extra space on each side away from vertical roller, and direct the hose toward the drum reducing the likelihood of the hose rubbing on the frame causing damage to the hose.

2. **Provide the distance of the center between each pair of mounting holes (Dimensions X and Y).**

The length of each roller (Dimensions W=Vertical Roller Length and Z=Horizontal Roller Length) will vary depending on the X and Y dimensions provided.

Note: If you are mounting rollers to an existing reel, please provide model and/or serial number of the reel and we can build rollers to that specific model.

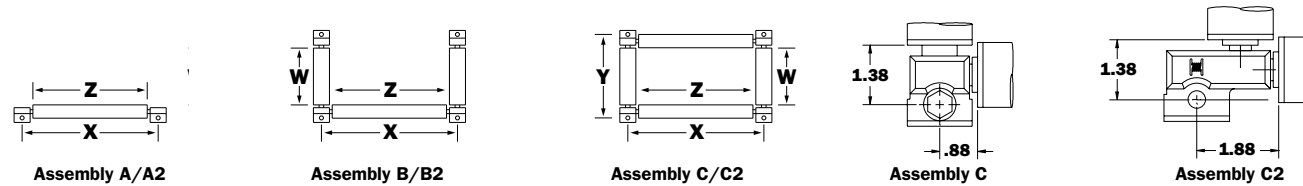

For information on Roller Assembly parts visit the [Parts Drawing](#) section on our website.
For Installation Instructions visit the [Maintenance & Installation Guides](#) section on our website.

Accessories

- Spring Rewind Reel Roller Assemblies
- FH-3 Roller & Spool Assemblies & Parts

Roller Assemblies for Spring Rewind Reels

These 4-way roller assemblies are for use on the reel, on cabinet door openings, and for similar locations where sharp metal edges may cut or damage the hose/cable. Four-way design protects hose even when payout or rewind is at an angle.

The N200 and R200 roller assemblies have Delrin rollers mounted in stamped steel housings for flush panel mounting, reel mounting (R200) or right-angle mounting (N200).

The R300 roller assemblies have stainless steel rollers, Delrin bearing inserts, and zinc die-cast corner mounting blocks assembled on a steel mounting frame.

To Order: Consult factory with model number to ensure proper roller assembly fit.



FH-3 Roller and Spool Assembly

Not recommended for hoses larger than 1-1/2" ID

Speeds handling and reduces hose wear. Buffed stainless steel rollers resist corrosion, pitting, and abrasion. Polished, chrome-plated spools and blocks add lasting beauty to your equipment. Delrin bearing surfaces assure quiet operation and minimum wear. Assembly can be factory installed, when specified, or ordered for field installation on reels or other equipment.

To Order: For factory installation, specify FH-3 Assembly and indicate position on reel. As an accessory, specify FH-3 Assembly and give length of roller (Dimension Z), and distance between mounting holes (Dimension X). Mounting brackets are available.

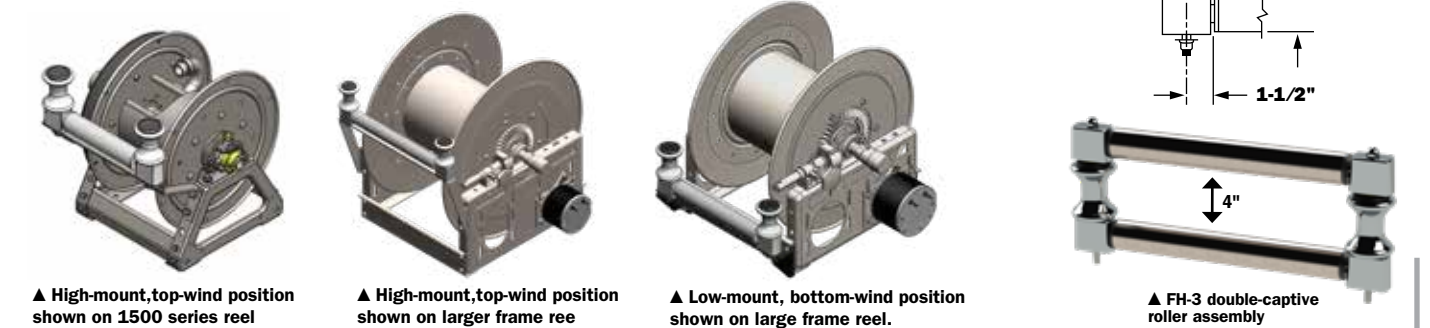

For information on Roller Assembly parts visit the [Parts Drawing](#) section on our website.
For Installation Instructions visit the [Maintenance & Installation Guides](#) section on our website.

Accessories

- Hose and Cable Stops
- Hose Assemblies

Hannay Reels **Accessory Order Form**

To order any of the accessories shown in this catalog, please provide the following information to your Hannay Reels dealer.

Hose and Cable Stops

Recommended with all spring rewind reels and 4-way roller assemblies.

- All stops are quickly installed with included plated fasteners.
- The HS-35 is our standard stop, used for most applications up to and including 1" ID hose.
- HS-35 two-piece stops are molded from EPDM rubber for durability and maximum grip.
- HS-3 and HS-45 two-piece stops are molded from polypropylene, and are custom drilled to the size you specify.

To Order: Use Hannay part number from chart below (specify single or twin hose). Specify the outside diameter (OD) of your hose or cable. Please note that for the plastic stops, the drilled hole size will be 1/16" (single hose) or 1/32" (twin hose) **smaller** than the OD of the hose you specify to ensure a good grip.

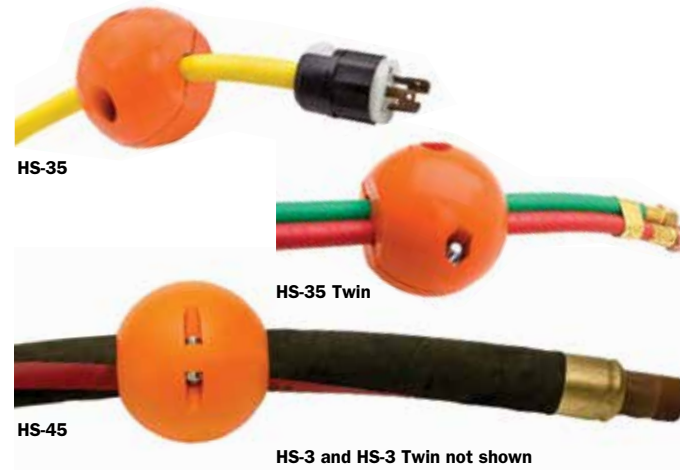

Part Number	Description	Spherical OD	Min. Hose or Cable OD	Max. Hose or Cable O.D.	Material	Best Used
9922.0200	HS-35	3.5"	0.44"	1.53"	EPDM Rubber	1/4" – 1" ID hose; Most multi-gauge cable
9922.0210	HS-35 Twin	3.5"	0.47"	0.91"	EPDM Rubber	1/4" – 1/2" Twin ID hose
9922.0012	HS-45	4.5"	None (drilled)	2.69"	Plastic	1-1/4" – 2" hose
(specify single or twin)	HS-45 Twin	4.5"	None (drilled)	1.28"	Plastic	3/4" Twin ID hose
9922.0111	HS-3	3.0"	None (drilled)	1.81"	Plastic	Hose/cable OD less than 0.44"
(specify single or twin)	HS-3 Twin	3.0"	None (drilled)	0.91"	Plastic	Twin hose OD less than 0.47"

Hose Assemblies

Allow us to quote hose along with the reel to simplify your procurement process. Hannay inventories a wide variety of hose assemblies for common applications like general purpose air or water, petroleum products, hydraulics, oxygen/acetylene, breathing air, and rescue equipment. Special lengths, fittings, and custom application assemblies are usually available in 5 to 10 business days. Beside the ID and Length, be sure to know the Temperature Range, Fluid, Working Pressure, and Fitting Specifications for your hose.

Low Pressure Hose

We stock a variety of low pressure hose assemblies in several sizes and lengths. We offer hose with EPDM cover and tube and brass fittings, which are excellent for air, water, and many agricultural chemicals. EPDM is recommended for outside usage due to its resistance to heat, sunlight, and weathering.

For shop use, we offer a hose with high oil resistant tube and cover. It is suitable for use with petroleum based hydraulic fluid, lubricating oil, anti-freeze, diesel fuel, water, and air and may be special ordered in several different colors. Hoses for specialty applications are available upon request.

Medium and High Pressure Hose

Several different hydraulic and general purpose hose assemblies are offered to meet the specifications of your particular application. We stock an assortment of common sizes to be able meet your needs with a minimum delivery time.

Twin Hydraulic Hose

Hannay Reels offers bonded hydraulic hose that helps solve problems associated with unwinding and storing multiple lines. Various options are available not only for hydraulic fluid, but a wide variety of chemicals, agricultural sprays, urethane foam mixers, and fire resistant fluids.

Twin Oxygen/Acetylene Hose

We stock Grade R and Grade T twin hose assemblies in 1/4" and 3/8" in lengths of 50', 75', and 100' which will cover most requirements for oxygen/acetylene, as well as propane and MAPP. For oxygen/acetylene reels, see our Welding Reels Catalog.

Mounting Hole Sizes	
N Series Reels	7/16" wide x 7/8" long slot running front to back
Pressed Frame Reels and Channel Framed Reels	7/16" wide x 7/8" long slot running left to right
Series 1000	7/16" wide x 1 7/16" long slot
Series 1500, 1800, 2000, 4000	13/32" round holes

1. Who is the reel for?

Contact		Date / /	
Company		Division	
Street Address			
City	State	Zip	Country
Telephone ()		Fax ()	

2. What accessories are needed?

Item name: _____

Part #: _____

Page #: _____

Reel model: _____

Reel serial #: _____

3. What are the specifications?

Please note: Provide any specifications called for in accessory description.

Item name: _____

Part #: _____

Page #: _____

Reel model: _____

Reel serial #: _____

Item name: _____

Part #: _____

Page #: _____

Reel model: _____

Reel serial #: _____

Item name: _____

Part #: _____

Page #: _____

Reel model: _____

Reel serial #: _____

Contact our sales department at **1-877-467-3357** or online at **hannay.com**

Find reels for every need.

Learn more about all of our reels, including specs, drawings, and even how to select the right reels and accessories for your industry.

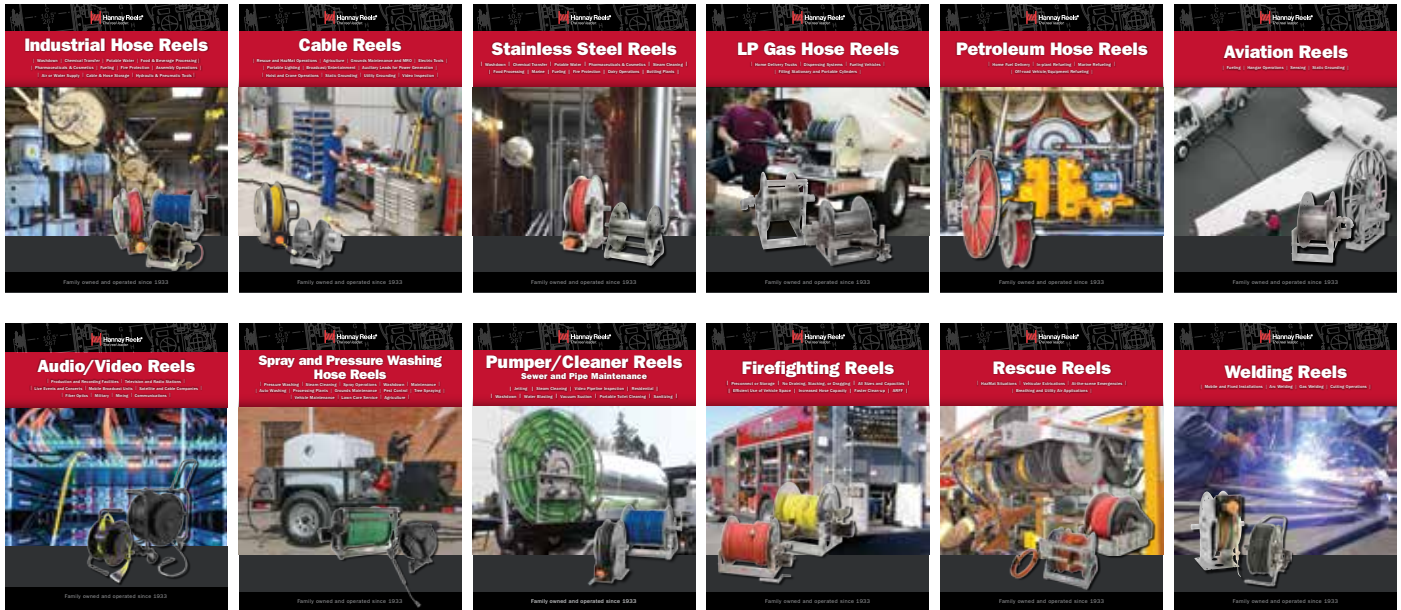

View all our reel catalogs online at **hannay.com**



Family owned and operated since 1933, Hannay Reels is the world leader in both OEM and aftermarket applications. Hannay offers thousands of standard hose reel and cable reel models, as well as unmatched custom capabilities. We can easily and affordably customize a reel to meet your exact specifications – built to last, delivered fast. Additional catalogs are available through your local Hannay Reels dealer or online at **hannay.com**.



553 State Route 143 | Westerlo, New York 12193
 Email: reels@hannay.com | hannay.com

All Hannay reels are constructed of quality heavy gauge steel (optional aluminum or stainless steel also available on most models).



AU | reeltech.com.au
sales@reeltech.com.au
 Free call: 1800 REELIN

NZ | reeltech.co.nz
sales@reeltech.co.nz
 Free call: 0800 REELIN

